



# TABLE OF CONTENTS

IPC M300.....	4
Installation Diagram .....	4
Connection to the IPC M300.....	5
Interface.....	6
EoC Manage.....	6
CNU list .....	7
CNU Query.....	10
Slave template.....	11
Template Apply .....	12
Whitelist Setting .....	13
Wte List Setting:.....	13
Execute unknow devices default white list:.....	13
Sync Configure.....	14
Update Configure.....	15
System management.....	18
System information.....	18
Save configuration.....	19
Export configuration.....	19
Restore default.....	20
Config Upgrade .....	20
Firmware update.....	21
Reboot System.....	21
Device management .....	22
Port.....	22
VLAN.....	23
Rate limit .....	23
User manage.....	24
User list.....	24
Add User.....	24
Edit User.....	25

Del User.....	25
RF.....	26
Level and Bandwidth.....	26
Advanced Setting.....	27
Working Channel.....	27
Relay Settings.....	28
Output Level.....	28
Broadcast Storm Control.....	29
QoS.....	30
Logout.....	30

## IPC M300.



-LED: LEDs specify the following; LINK if any equipment is connected, POWER if there is power, EOC if the RF chip is correct, SYSTEM the system status. E1 and E2 displays the traffic status of the DATA IN 1 and 2.

-MGMT/DATA IN X: This port enables the internet traffic to proceed and to be connected to the equipment via the IP - 192.168.1.254.

-RESET: Resets the equipment to factory default values.

-CONSOLE: Connection would be for link up to the computer.

-RF: Output to mix in coaxial installation.

## Installation Diagram.

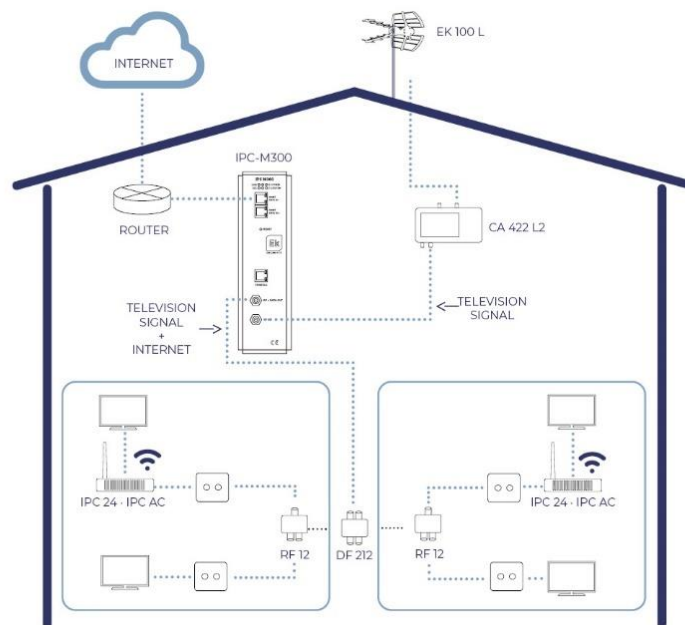

## Connection to the IPC M300.

For connection to the IPC M300, follow the steps specified below:

1. Connect to the IPC M300 using a network cable or wirelessly.
2. Configure the PC's network adapter using a static IP:

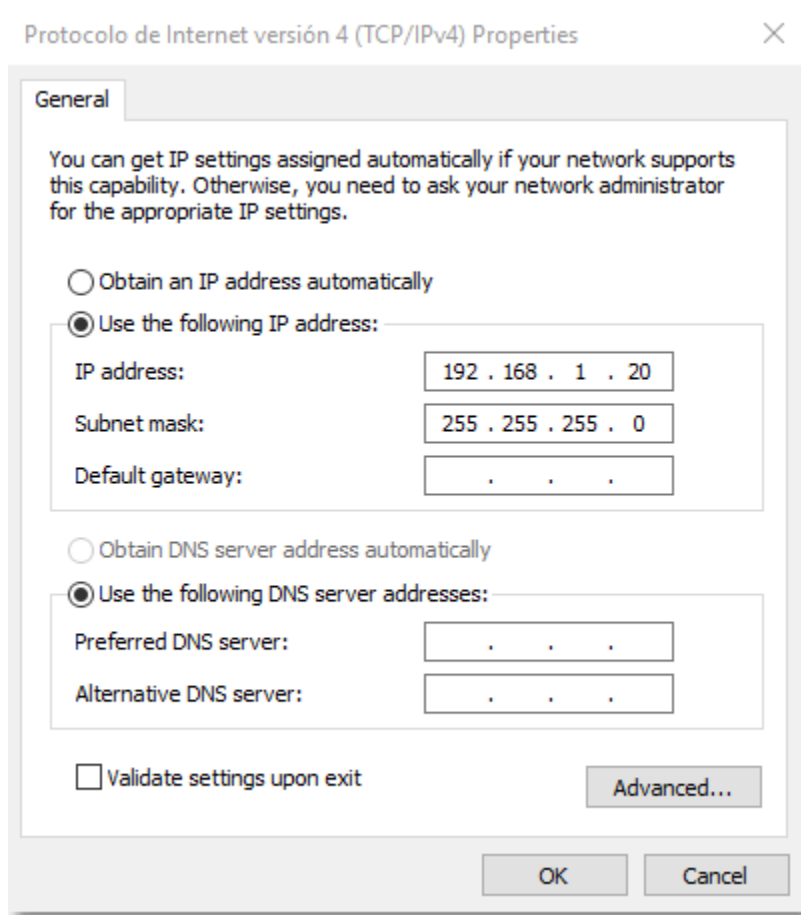

3. Open a web browser and go to the URL: <http://192.168.1.254/>
4. The username and password is **admin / admin**.

## Interface.

The screenshot shows a web interface with a dark blue sidebar on the left containing a menu with the following items: EoC Manage, System Manage, Device Manage, User Manage, RF, Advanced Settings, and Logout. The main content area displays two tables:

Host Info	
Host Name	EocMaster
System Location	DefaultsysLocation
<input type="button" value="Apply Changes"/>	

Product Info	
Product Name	ANM8001H
Base Mac	1c184a31c787
System Name	NMS1000
Hardware Version	Version 1.0
Bootrom Version	V5
Software Version	NMS1000 11.3.00(ODM), Release(38839)
Uptime	68 days, 18 hours, 0 minites, 43 seconds

## EoC Manage.

In this menu everything related to the slaves/user equipment which is connected to the master unit may be managed.

A close-up view of the sidebar menu with the following items: EoC Manage, System Manage, Device Manage, User Manage, RF, Advanced Settings, and Logout. Each item is preceded by a small square icon.

## CNU list.

Displays all the equipment connected to the master.

The screenshot shows a web interface with a sidebar menu on the left and a main table titled "CNU List". The sidebar menu includes options like EoC Manage, CNU List, CNU Query, Slave Template, Template Apply, Whitelist Setting, Sync Configure, Update Configure, System Manage, Device Manage, User Manage, RF, Advanced Settings, and Logout. The "CNU List" table has columns for Port, TEI, MAC, Model, Soft Version, Link, Down Stream (Mbps), Up Stream (Mbps), Avg Attenuation / Carrier(dB), Auth, Enable Template, White List, User Name, Description, and Action. Three rows of equipment are listed, each with a "Mana Del" link in the Action column. At the bottom right of the table are "Apply template" and "Cancel" buttons.

Port	TEI	MAC	Model	Soft Version	Link	Down Stream (Mbps)	Up Stream (Mbps)	Avg Attenuation / Carrier(dB)	Auth	Enable Template	White List	User Name	Description	Action
unknown	3	741a.e0e4.a840	ANS5004WAC	2.0.30748	✗	0	0	0	YES	<input type="checkbox"/>	<input checked="" type="checkbox"/>			Mana Del
unknown	5	741a.e0e6.1beb	ANS5004WAC	2.0.33286	✗	0	0	0	YES	<input type="checkbox"/>	<input checked="" type="checkbox"/>			Mana Del
unknown	4	1c18.4a34.8b47	ANS5004WAC	2.0.30748	✗	0	0	0	YES	<input type="checkbox"/>	<input checked="" type="checkbox"/>			Mana Del

If any template is configured, the enable template option may be selected and then to apply the template to the equipment that is wished to be configured.

Furthermore, if an individual configuration is wished to be made in the Action column, click on the "Mana" button to go to the slave settings.

## Slave configuration.

By clicking on the "Mana" button, this accesses the slave. Various menus will be displayed where different information may be obtained.

The screenshot shows a configuration page with a top navigation bar containing "Basic Status", "Other Status", "MPDU", "Signal", "Edit", "Qos", "Update", "Sync", "Manage", and "Advance". The main content is a table titled "Basic Status" with the following fields and values:

Basic Status	
MAC Address	1c18.4a34.8b47
Link Information	Link Up
Device Type	ANS5004WAC
System Version	2.0.18332
EoC Version	INT7400-MAC-7-1-7131-00-17-20131108-FINAL-QCA7411L-B
UserName	
TelePhone	
Contact Address	
Description	

**Signal.**

Displays the slave's RF signal levels

Signal Statistics			
Rx Stats			
Pre-FEC Bit Error Rate:	0.000000%	Dest PB CRC Error Rate:	0.000000%
Available Margin:	0.000000%	Avg Bits/Carrier	0.000000
Avg SNR/Carrier:	0.000000dB	Avg Attenuation/Carrier	0.000000dB
Avg Output Power/Carrier:	0.000000dBm/Hz		
Tx Stats			
Source PB CRC Error Rate:	0.000000%	Avg Bits/Carrier	0.000000
Avg SNR/Carrier:	0.000000dB	Avg Attenuation/Carrier:	0.000000dB
Avg Output Power/Carrier:	0.000000dBm/Hz		

**Edit.**

Enables to identify the slave and its basic information. Limits the equipment's overall bandwidth and in the Interface section the desired interfaces can be added or configured.

Basic Information		
MAC Address	1c18.4a34.75cf	
User Name	<input type="text"/>	
Telephone	<input type="text"/>	
Contact Address	<input type="text"/>	
Description	<input type="text"/>	
Choose Template	Custom ▾	
Cable Bandwidth		
Uplink Limit	0 Kbps	
Downlink Limit	0 Kbps	
MAC Address Limiting		
MAC Number Limit	0 (0 means limit disabled)	
NetWorks		
Interface Name	Port Map	Operate
1_INTERNET_R_VID_-1		
<input type="button" value="Add"/>		
LAN		
<input type="button" value="LAN"/>		
WLAN		
<input type="button" value="WLAN"/>		
<input type="button" value="Apply Changes"/>		

The different menus - LAN, WLAN and if the equipment is AC - the WIFI 5G menu, then their respective options can be configured.



WAN.

More than one WAN may be added if it is required to make use of additional services otherwise the existing WAN will be modified by establishing as to whether the equipment operates in Bridge or Router mode. The WAN likewise enables establishing a VLAN as well as to select the ports which will be linked to same in order to provide the service.

NetWorks Setting	
VLAN ID	-1 (-1,1~4093), -1: mean not set VLAN ID
802.1p	0
Internet Name	INTERNET
Service Mode	Route
Enable NAT	<input checked="" type="checkbox"/>
Link Type	DHCP
PortMap	<input type="checkbox"/> LAN1 <input type="checkbox"/> LAN2 <input type="checkbox"/> LAN3 <input type="checkbox"/> LAN4 <input type="checkbox"/> WLAN1 <input type="checkbox"/> WLAN2 <input type="checkbox"/> WLAN3 <input type="checkbox"/> WLAN4
<input type="button" value="Apply Changes"/> <input type="button" value="Cancel"/>	

LAN.

LAN Settings			
IP Address	192.168.1.1	Note: change the IP, will change the IP pool	
Subnet Mask	255.255.255.0		
DHCP Server Enable	<input checked="" type="checkbox"/>		
DHCP List			
Network type	Start IP	End IP	Leasetime (1~24 hours)
STB	192.168.1.10	192.168.1.20	12
Phone	192.168.1.30	192.168.1.40	12
Camera	192.168.1.50	192.168.1.60	12
Computer	192.168.1.70	192.168.1.80	12
DNS Settings			
Manual DNS	<input type="checkbox"/>		
<input type="button" value="Apply Changes"/> <input type="button" value="Cancel"/>			

WLAN.

In this section up to 4 SSID, with their respective parameters may be configured.

Wireless Settings	
Enable Wireless	<input checked="" type="checkbox"/>
Basic Settings	
Network Type	802.11b/g/n Mixed
Channel	6
Channel Bandwidth	20 MHz
Rate	Auto (The rate in bracket is for double antennas)
Tx Power	100%
Guard Interval	Short
Country Code	China
Security Settings	
SSID Index	SSID1
SSID	RL-SSID1
Enable SSID	<input checked="" type="checkbox"/>
Hidden SSID	<input type="checkbox"/>
AP Isolation	<input type="checkbox"/>
Encrypt Type	WPA-PSK
WPA Cipher	AES
WPA Key	***** the length of key is no less than 8 and no more than 64.

Once these changes are completed, the changes will be implemented.

CNU Query.

We can perform a search for the slave we need according to the allowed parameters.

- EoC Manage
- CNU List
- CNU Query
- Slave Template
- Template Apply
- Whitelist Setting
- Sync Configure
- Update Configure
- System Manage
- Device Manage
- User Manage
- RF
- Advanced Settings
- Logout

Query Condition	
MAC Address	<input type="text"/> (Format:H.H.H)
User Name	<input type="text"/>
Telephone	<input type="text"/>
Contact Address	<input type="text"/>
Description	<input type="text"/>
<input type="button" value="Query"/>	

CNU List														
Port	TEI	MAC	Model	Soft Version	Link	Down Stream (Mbps)	Up Stream (Mbps)	Avg Attenuation / Carrier(dB)	Auth	Enable template	White List	User Name	Description	Action
unknow	2	741a.e0e4.a840	ANS5004WAC	2.0.30748	✗	0	0	0	YES	<input type="checkbox"/>	<input checked="" type="checkbox"/>			Mana Del
unknow	0	741a.e0e6.f94f	MSS5004W		✗	0	0	0	YES	<input type="checkbox"/>	<input checked="" type="checkbox"/>			Mana Del
unknow	0	741a.e0e6.1beb	ANS5004WAC		✗	0	0	0	YES	<input type="checkbox"/>	<input checked="" type="checkbox"/>			Mana Del
unknow	0	741a.e0e4.6abb	MSS5004W		✗	0	0	0	YES	<input type="checkbox"/>	<input checked="" type="checkbox"/>			Mana Del
unknow	0	741a.e0e4.130c	ANS5004WAC		✗	0	0	0	YES	<input type="checkbox"/>	<input checked="" type="checkbox"/>			Mana Del

## Slave template.

The general template may be configured here which can be applied to the equipment.

The previous section clearly describes how to implement a template and the different elements comprising same.

The screenshot displays the configuration interface for the Slave Template. On the left is a navigation menu with options like EoC Manage, System Manage, and Device Manage. The main content area has a top navigation bar with tabs: Basic Status, Other Status, MPDU, Signal, Edit, Update, Sync, Manage, and Advance. The configuration is organized into several sections:

- Basic Information:** Fields for MAC Address (741a.e0e4.a840), User Name, Telephone, Contact Address, and Description. A 'Choose Template' dropdown is set to 'Custom'.
- Cable Bandwidth:** Fields for Uplink Limit and Downlink Limit, both set to 0 Kbps.
- MAC Address Limiting:** A 'MAC Number Limit' dropdown set to 0, with a note '(0 means limit disabled)'. Below this is an 'Add' button.
- NetWorks:** A table with columns 'Interface Name', 'Port Map', and 'Operate'. The first row shows '1\_INTERNET\_R\_VID\_-1' with port map 'lan1 lan2 lan3 lan4 wlan1 wlan5' and an 'Operate' icon. Below the table are buttons for 'LAN', 'WLAN', and 'WIFI 5G'. An 'Apply Changes' button is at the bottom right.

## Template Apply.

By default the template is deactivated as "close" and if wishing to use the template configure same as "open".

- EoC Manage
  - CNU List
  - CNU Query
  - Slave Template
  - Template Apply
  - Whitelist Setting
  - Sync Configure
  - Update Configure
- System Manage
- Device Manage
- User Manage
- RF
- Advanced Settings
- Logout

Template Switch	
Apply the template to registered devices	close ▾
<input type="button" value="Save"/> <input type="button" value="Apply Template"/>	

## Whitelist Setting.

By default "Whitelist function" is disabled. This allows all slaves to be added automatically and functional. If you want to restrict them from working directly, you must mark "On".

### White List Setting:

- **Whitelist function:** For the whitelist configuration to be applied, this option must be enabled. By default all slaves are added automatically.
- **Register default device whitelist:** Automatically register slaves. It must be configured in reverse of the following.
- **Unregister from the default device whitelist:** Disables registration of slaves. It must be configured in reverse of the previous one.
- **Unknown default devices whitelist:** Whitelists computers that are other models of whitelisted slaves.

### Execute unknow devices default white list:

- **Run the default whitelist of unknown devices now:** Add all unknown devices.

## Sync Configure.

This option describes the configuration address.

Set Sync Direction	
Sync Direction (only valid for registered gateway slave)	from master to slave ▼
<input type="button" value="Apply Changes"/>	

From master to slave: As its name implies the configuration which will prevail is that of the master over slave

From slave to master: The configuration which prevails here is that of the slave. This mode is used when the master will not be utilised.

Auto Sync	
Enable Auto Sync	Enable ▼
Set Sync Interval	1 (1 ~ 10080 minutes)
<input type="button" value="Apply Changes"/>	

This option synchronises the slave configuration automatically every x minutes if enabled. Ideal to prevent factory default resets in the equipment and which lose their configuration.

## Update Configure.

This step must be performed slave by slave. It is also important to know that it can only be updated if the slave is in Route mode. slaves in bridge mode cannot be updated in this way.

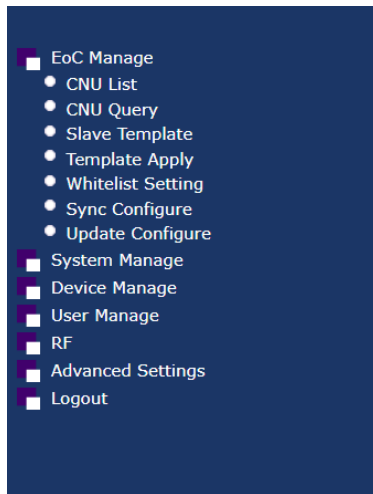

Update Configure					
Update Mode	TFTP				
Server IP	0.0.0.0				
					Apply Changes
CNU System Update Mode Configure					
Model	Mode	Update Address	Filename	Version	
Add					

To update slaves remotely we will follow the following steps, keep in mind that you must add as many models as you need to update:

1. Click Add.
2. Fill in the fields of "System Update Settings".

CNU System Update Configure	
Devtype Name:	ANS3003
Mode:	TFTP
Server Ip:	
File Name :	
CheckNum:	
Version:	
Keep Configuration:	<input checked="" type="checkbox"/>
<input type="button" value="Apply Changes"/> <input type="button" value="Cancel"/>	

- o Device Name: We will have to select the "Model". We can see it in the table of slaves [CNU list](#).

- IP server: The IP of the PC or computer that we use as a server. We will have to install some program such as TFTP32 to use TFTP server.
  - File Name: Name of the file that we are going to use to update the slave. Full file name.
  - Control number: They must locate the MD5 File Checksum of the file. For this you can use web pages or applications.
  - Version: This data comes in the name of the file itself after a letter "r". For example in a file "MSS5004W\_EK\_r32321\_U.bin" the version would be "r32321".
  - Keep the configuration: We enable the check if we do not want that once updated make a factory reset.
3. Select "Mana" in CNU List.

The screenshot shows the 'CNU List' interface. On the left is a sidebar menu with 'CNU List' selected. The main area contains a table with the following data:

Port	TEI	MAC	Model	Soft Version	Link	Down Stream (Mbps)	Up Stream (Mbps)	Avg Attenuation / Carrier (dB)	Auth	Enable Template	White List	User Name	Description	Action
unknown	2	741a.e0e4.a840	ANS5004WAC	2.0.30748	X	0	0	0	YES	<input type="checkbox"/>	<input checked="" type="checkbox"/>			Mana Del
unknown	0	741a.e0e6.f94f	MSS5004W		X	0	0	0	YES	<input type="checkbox"/>	<input checked="" type="checkbox"/>			Mana Del
unknown	0	741a.e0e6.1beb	ANS5004WAC		X	0	0	0	YES	<input type="checkbox"/>	<input checked="" type="checkbox"/>			Mana Del
unknown	0	741a.e0e4.6abb	MSS5004W		X	0	0	0	YES	<input type="checkbox"/>	<input checked="" type="checkbox"/>			Mana Del
unknown	0	741a.e0e4.130c	ANS5004WAC		X	0	0	0	YES	<input type="checkbox"/>	<input checked="" type="checkbox"/>			Mana Del

Buttons at the bottom right: Apply template, Cancel

4. We access the option of "Update".

The screenshot shows the 'Update' configuration page. The sidebar menu is on the left. The main area has tabs: Basic Status, Other Status, MPDU, Signal, Edit, Update (selected), Sync, Manage, Advance.

**CNU EOC Module Update**

Please input the update filename:  (filename's length not longer than 25)

Note that when updating please donot power down

EoC Module Update Status: none

**CNU System Update**

Please set update infos at first:

Note that when updating please donot power down

System Update Status: none

**CNU EOC Module PIB DOWNLOAD**

Note that when downloading please donot power down



5. Pressed "Update".

Basic Status	Other Status	MPDU	Signal	Edit	Update	Sync	Manage	Advance
<b>CNU EOC Module Update</b>								
Please input the update filename:		<input type="text" value=""/>						
								(filename's length not longer than 25)
Note that when updating please donot power down						<input type="button" value="Update"/>		
EoC Module Update Status		none						
<b>CNU System Update</b>								
Please set update infos at first:								
Note that when updating please donot power down						<input type="button" value="Update"/>		
System Update Status		none						
<b>CNU EOC Module PIB DOWNLOAD</b>								
Note that when downloading please donot power down						<input type="button" value="Download"/>		

If you can not download the file by TFTP it may be a problem of the Windows firewall or that some parameter has been misplaced in "System update settings.

- After a few minutes we restart the master and the new version of the slave will appear. We will see that it is done and open finished the TFTP download.

## System management.

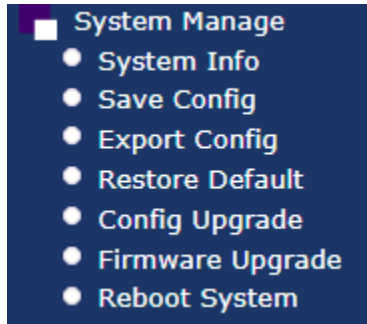

## System information.

Provides information as regards the system, identifies the equipment with name and location.

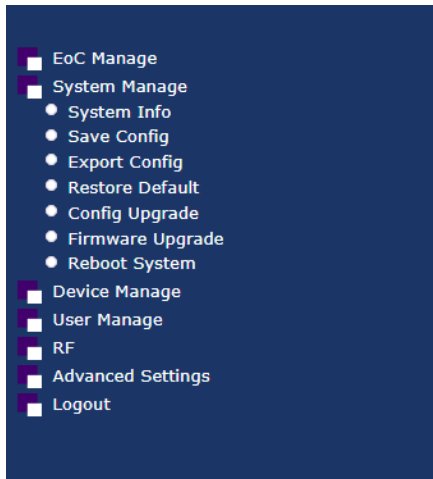

Host Info	
Host Name	EocMaster
System Location	DefaultsysLocation
<input type="button" value="Apply Changes"/>	

Product Info	
Product Name	ANM8001H
Base Mac	1c184a31c787
System Name	NMS1000
Hardware Version	Version 1.0
Bootrom Version	V5
Software Version	NMS1000 11.3.00(ODM), Release(38839)
Uptime	68 days, 18 hours, 7 minutes, 47 seconds

### Save configuration.

Menu for saving the latest settings. After each modification made in the master or in the configuration of the slaves stored in the master in it, menu "EoC Manage" must be saved. Otherwise the reboot will not dump the modified configuration.

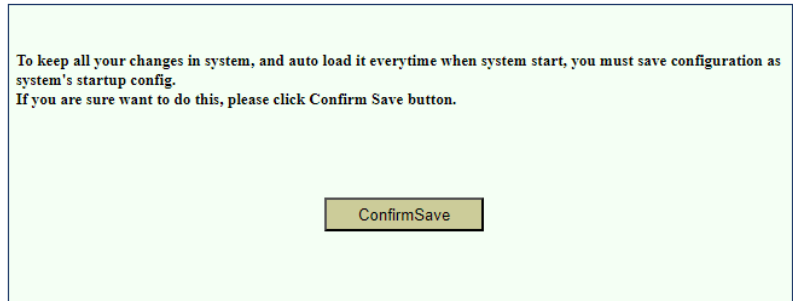
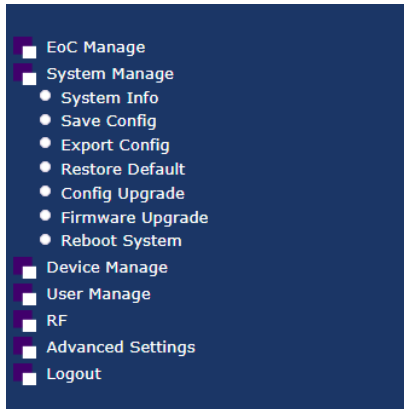

### Export configuration.

Exports the master's configuration.

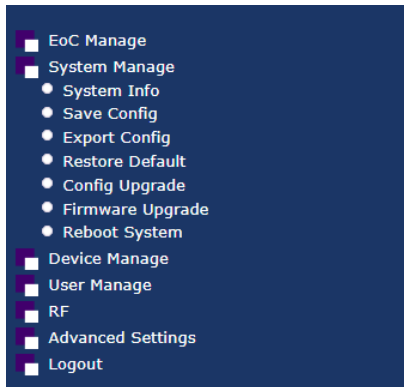

The resulting file can be imported into any computer by loading it as if it were a new FW in "Firmware Update". Note that the configuration loaded into the master comes from another master with the same model and version of FW.

## Restore default.

Restores the master to factory default settings.

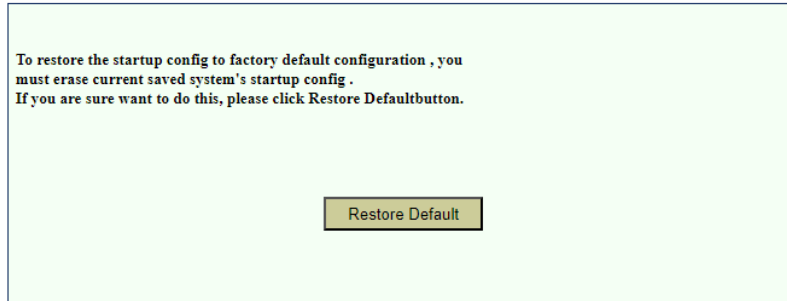
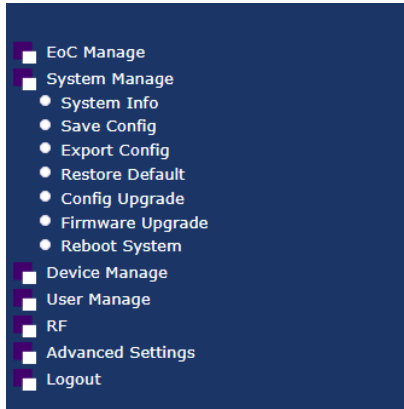

## Config Upgrade.

We can import the file we create when we make a backup. By default, the file name is "rlos\_cfg.install".

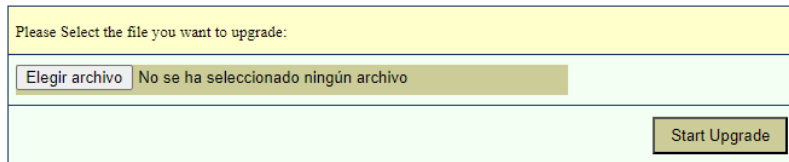
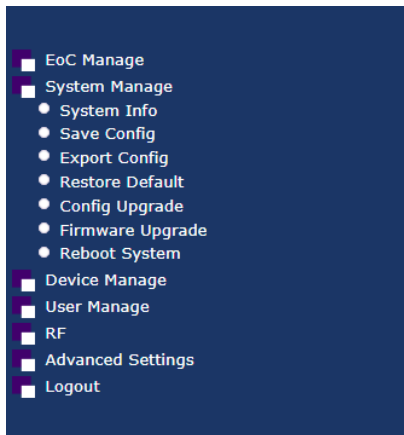

## Firmware update.

Select the new firmware to update the master. IT IS IMPORTANT TO VERIFY THAT THE FILE YOU ARE GOING TO UPLOAD IS A '.install' EXTENSION SINCE THE FILE YOU DOWNLOAD MAY BE A '.zip' FILE, SO YOU WILL HAVE TO UNZIP IT BEFORE UPLOADING IT TO THE MASTER.

After updating, it is recommended to perform a 'Default Restore' so that the update is applied correctly.

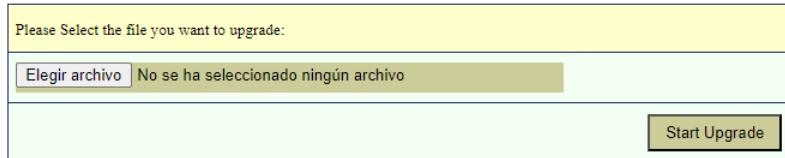
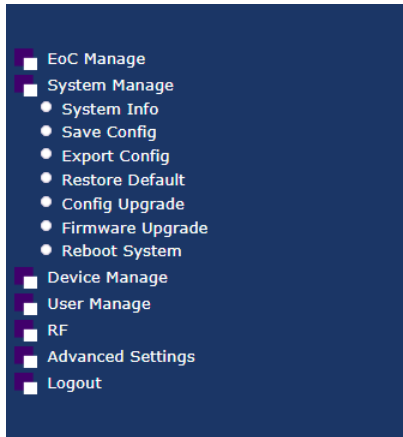

## Reboot System.

System reboot. Previously saved settings with the "Save Settings" option will not be lost.

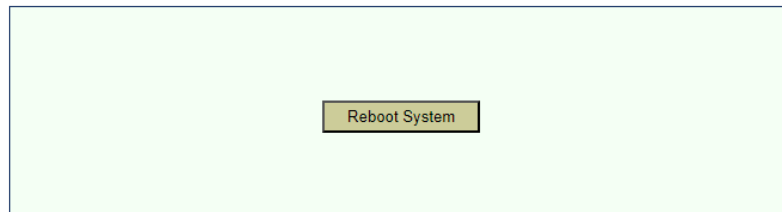
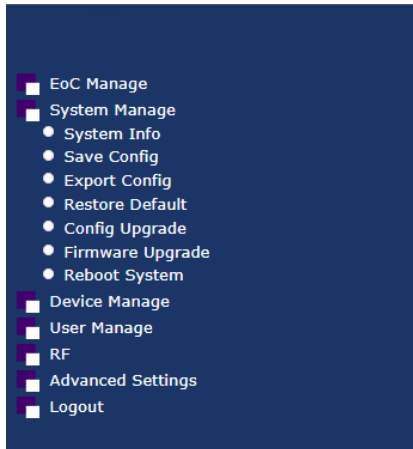

## Device management.

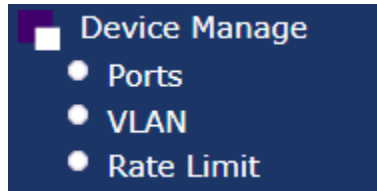

### Port.

It shows us the status of the different interfaces of the equipment.

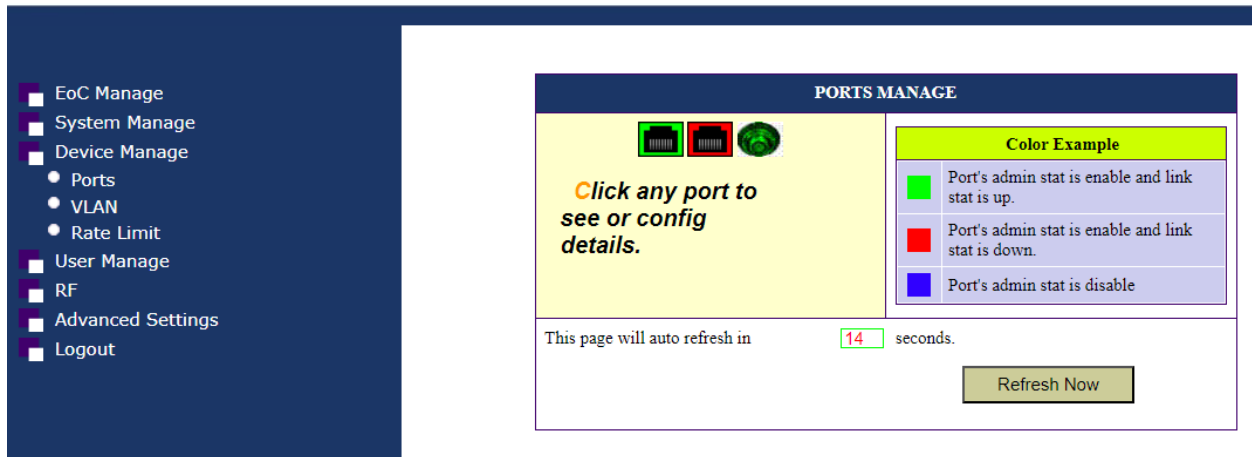

VLAN.

VLAN MANAGE	
VLAN list:	default <input type="button" value="Delete"/> <input type="button" value="Create"/>

VLAN Details	
VLAN NAME:	default
VLAN ID:	1
VLAN IP:	172.16.5.241
NETMASK:	255.255.255.0
GATEWAY:	
<input type="button" value="Change"/>	

VLAN PORTS	
Tagged ports:	
Untagged ports:	1 2
<input type="button" value="Config"/>	

The create button enables adding the VLANs that the Master will process. If the VLANs are not added and linked to the ports, their traffic will not proceed.

An IP for the master in each VLAN may be assigned.

The ports are as follows:

- 0:DATA IN 1.
- 1:Data IN 2.
- 2:RF+DATA OUT.

Rate limit.

It allows us to limit the traffic limit of the different interfaces by default is disabled.

Rate Limit		
Ports	Velocidad de bajada (0 ~ 1048512)	Velocidad de subida (0 ~ 1048512)
eth0/0	<input type="text" value="0"/> Kbps	<input type="text" value="0"/> Kbps
eth0/1	<input type="text" value="0"/> Kbps	<input type="text" value="0"/> Kbps
cable0/2	<input type="text" value="0"/> Kbps	<input type="text" value="0"/> Kbps
<input type="button" value="Apply Changes"/>		

- EoC Manage
- System Manage
- Device Manage
  - Ports
  - VLAN
  - Rate Limit
- User Manage
- RF
- Advanced Settings
- Logout

## User manage.

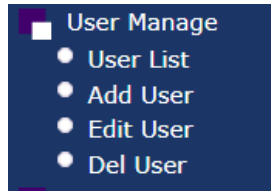

### User list.

It shows us the current users and the defined Role.

The screenshot shows a navigation menu on the left and a table titled "Current Users In System" on the right.

Current Users In System	
User Name	User Role
admin	Admin User
user	Normal User
Total 2 users in system.	

### Add User.

Allows us to create users.

The screenshot shows a navigation menu on the left and an "Add User" form on the right.

**Add User**

Please input the user's name and login password you want to add:

User Name:

Login Password:

Confirm Login Password:



### Edit User.

It allows us to modify the user's access password or change it to administrator use. The normal user will not have access to most options without being able to configure slaves.

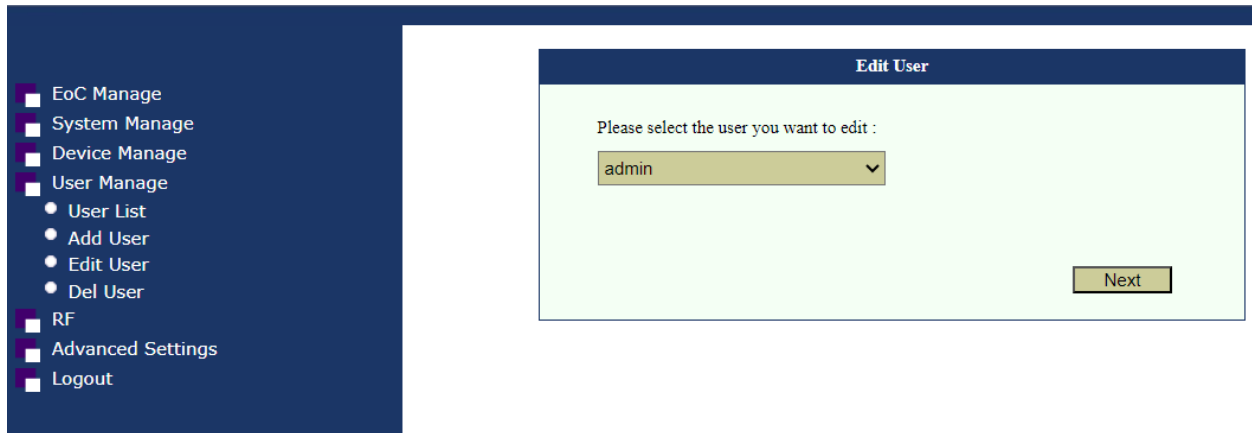

In case of losing access to the master by forgetting the password, the only way will be to perform a factory reset with the RESET button on the front. It should be held tight for about 30 seconds.

### Del User.

Allows us to delete a user.

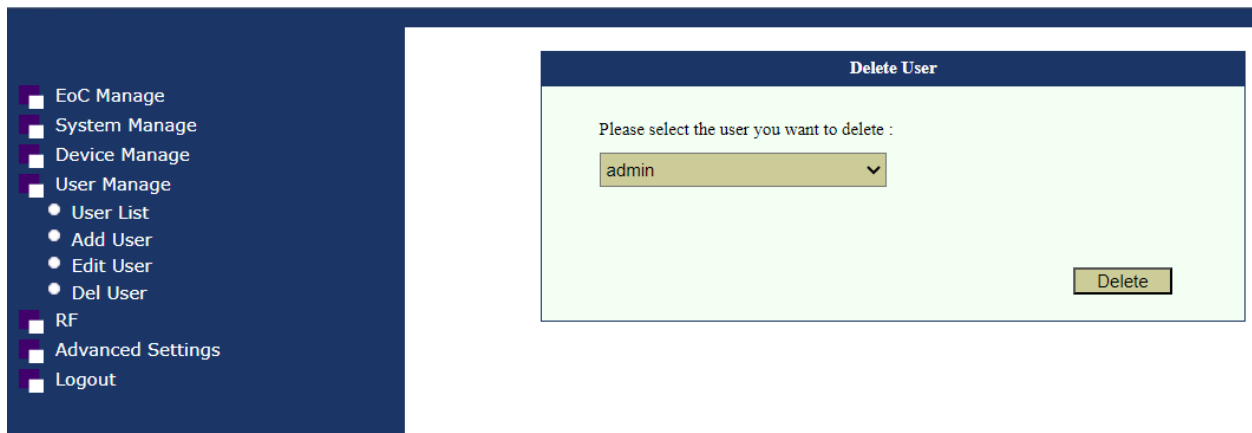

Caution do not delete the user with managed privileges. In this case, when losing access and management, they must perform a factory reset.

**RF.**

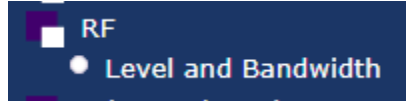

Level and Bandwidth.

Podemos ajustar el nivel de señal de salida. Es recomendable subir el nivel de salida a 112.

Level and Bandwidth	
Port	cab 0/2
outputlevel	112 dBuV (84-112)
startfreq	7.5 MHz
endfreq	67.5 MHz (22.5-67.5)
Apply Changes	

## Advanced Setting.



### Working Channel.

Stabilisce la forma di comunicazione da padrone a schiavo. Se c'è qualche problema quando si tratta di collegare lo slave con il master, non fanno un collegamento, potrebbe essere dovuto a questa opzione.

Se c'è qualche problema possiamo provare a mettere la seguente configurazione:

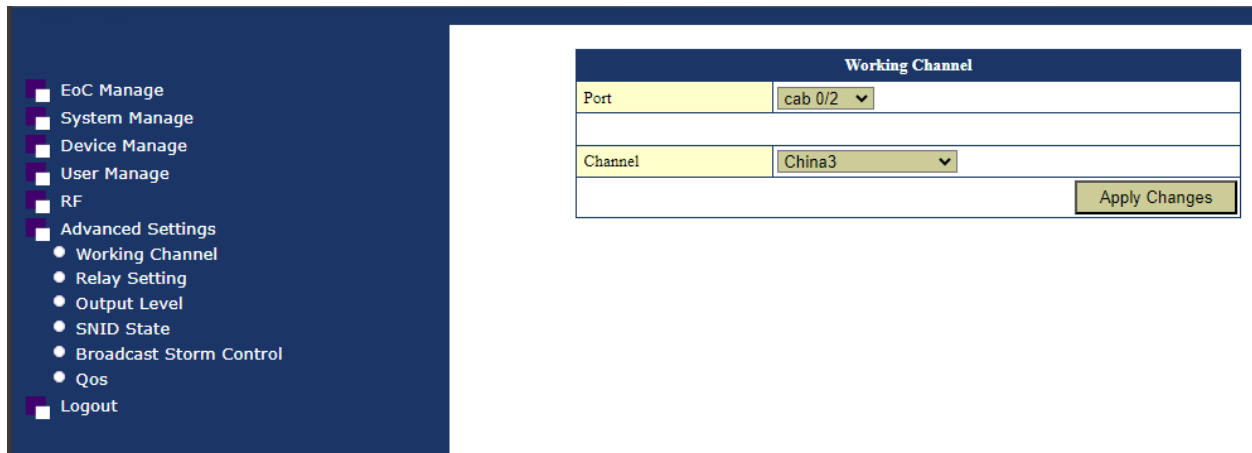

## Relay Settings.

Allows us to modify the NMK.

<ul style="list-style-type: none"> <li><input type="checkbox"/> EoC Manage</li> <li><input type="checkbox"/> System Manage</li> <li><input type="checkbox"/> Device Manage</li> <li><input type="checkbox"/> User Manage</li> <li><input type="checkbox"/> RF</li> <li><input checked="" type="checkbox"/> Advanced Settings             <ul style="list-style-type: none"> <li><input type="checkbox"/> Working Channel</li> <li><input checked="" type="checkbox"/> Relay Setting</li> <li><input type="checkbox"/> Output Level</li> <li><input type="checkbox"/> SNID State</li> <li><input type="checkbox"/> Broadcast Storm Control</li> <li><input type="checkbox"/> Qos</li> </ul> </li> <li><input type="checkbox"/> Logout</li> </ul>	<b>Relay Setting</b>	
	Port	cab 0/2 ▼
	MAC	f4:3e:61:dc:78:1c
	Software Version	INT7400-MAC-7-1-7131-00-17-20131108-FINAL-AR7410-D
	Module Type Name	7400(Master) ▼
	NMK	HomePlugAV (Default NMK:HomePlugAV)
	<input type="button" value="Apply Changes"/>	
	<input type="button" value="Download PIB File of EOC Module"/>	

## Output Level.

It allows us to attenuate the RF output in case we have interference with other devices in the same working band.

<ul style="list-style-type: none"> <li><input type="checkbox"/> EoC Manage</li> <li><input type="checkbox"/> System Manage</li> <li><input type="checkbox"/> Device Manage</li> <li><input type="checkbox"/> User Manage</li> <li><input type="checkbox"/> RF</li> <li><input checked="" type="checkbox"/> Advanced Settings             <ul style="list-style-type: none"> <li><input type="checkbox"/> Working Channel</li> <li><input type="checkbox"/> Relay Setting</li> <li><input checked="" type="checkbox"/> Output Level</li> <li><input type="checkbox"/> SNID State</li> <li><input type="checkbox"/> Broadcast Storm Control</li> <li><input type="checkbox"/> Qos</li> </ul> </li> <li><input type="checkbox"/> Logout</li> </ul>	<b>Adjust Output Level</b>	
	Coax Port2	disable ▼
		0dB ▼
	<input type="button" value="Apply Changes"/>	

## Broadcast Storm Control.

When it detects too much Broadcast, it would block broadcast traffic to slaves. Protection to avoid overflowing slaves for example if Broadcast traffic is introduced by mistake or necessity to the master.

The screenshot shows a web interface for configuring Broadcast Storm Control. On the left is a dark blue sidebar menu with the following items: EoC Manage, System Manage, Device Manage, User Manage, RF, Advanced Settings (with sub-items: Working Channel, Relay Setting, Output Level, SNID State, Broadcast Storm Control, Qos), and Logout. The main content area has a title 'Broadcast Storm Control' and a form with a 'Storm :' label and a dropdown menu currently set to 'disable'. An 'Apply Changes' button is located at the bottom right of the form.

QoS.

- EoC Manage
- System Manage
- Device Manage
- User Manage
- RF
- Advanced Settings
  - Working Channel
  - Relay Setting
  - Output Level
  - SNID State
  - Broadcast Storm Control
  - Qos
- Logout

Qos			
QOS Type		Default CAP <input type="button" value="v"/>	
VLAN Tag		TOS Bits	
Priority-0	<input type="button" value="Low"/> v	Priority-0	<input type="button" value="Low"/> v
Priority-1	<input type="button" value="Lowest"/> v	Priority-1	<input type="button" value="Lowest"/> v
Priority-2	<input type="button" value="Lowest"/> v	Priority-2	<input type="button" value="Lowest"/> v
Priority-3	<input type="button" value="Low"/> v	Priority-3	<input type="button" value="Low"/> v
Priority-4	<input type="button" value="High"/> v	Priority-4	<input type="button" value="High"/> v
Priority-5	<input type="button" value="High"/> v	Priority-5	<input type="button" value="High"/> v
Priority-6	<input type="button" value="Highest"/> v	Priority-6	<input type="button" value="Highest"/> v
Priority-7	<input type="button" value="Highest"/> v	Priority-7	<input type="button" value="Highest"/> v
Default CAP			
IGMP:	<input type="button" value="CAP 3"/> v	Unicast:	<input type="button" value="CAP 1"/> v
Managed Stream:	<input type="button" value="CAP 2"/> v	Multicast Broadcast:	<input type="button" value="CAP 1"/> v
<input type="button" value="Apply Changes"/>			
Qos			
Tx Buffer Allocation Based on Priority			
Enable	<input type="button" value="Disable"/> v		
Cap0 and Higher:	<input type="text" value="20"/> %	Cap1 and Higher:	<input type="text" value="25"/> %
Cap2 and Higher:	<input type="text" value="45"/> %	Cap3:	<input type="text" value="10"/> %
<input type="button" value="Apply Changes"/>			

Selecting the different "QoS Type" will apply the configured parameters.

- VLAN TAG: The priority is assigned according to configure the QOS in the slave.
- TOS Bits: The priority is assigned as we configure the QOS in the slave.
- Default CAP: QOS is applied depending on the type of traffic.

QOS TX Buffer Allocation Based on priority: We can enable it and reserve a % of traffic depending on the CAP assigned to it. Used only when the "Default CAP" option is selected."

**Logout.**

It allows us to go to the initial menu to access with our user and choose language.

•• This manual has been developed to provide guidance and support. However, the company assumes no responsibility for potential errors, omissions, or changes in the procedures described herein. We reserve the right to make modifications to the content of the manual without prior notice.