



EKSELANS BY ITS

2 WIRES VIDEO DOOR ENTRY SYSTEM WITH MIFARE RFID ACCESS CONTROL



ENTER THE EK WORLD



2 WIRES VIDEO DOOR ENTRY SYSTEM WITH MIFARE RFID ACCESS CONTROL



General features

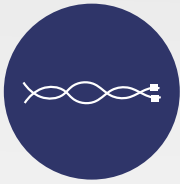

Non-polarized 2 wires system

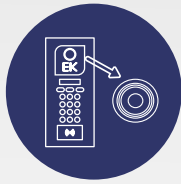

Digital outdoor panel in stainless steel with high quality color camera

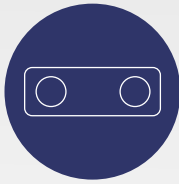

New Outdoor Panels with Push Buttons



Auto-adjusting light sensor



Compatible with outdoor door lock



LCD display with simple and intuitive directory



Audio call volume adjustment on monitor

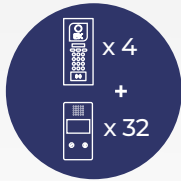

Up to 4 outdoor panels and up to 32 users (64 indoor units max)

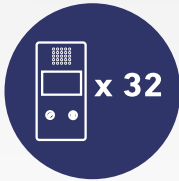

Extension Unit for Over 32 Monitors



Monitoring function. Possible to watch the street without prior call



Easy to install and to program



Integrated MIFARE access control



Paralell or series installation option



It can be used as replacement using existing cabling

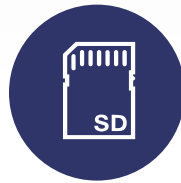

SD card slot



Opción de cámaras CCTV adicionales



Additional CCTV cameras option



OUTDOOR PANEL (PCD E) WITH PLASTIC FRAME FOR SURFACE MOUNTING



OUTDOOR PANEL (PCD-E-B)



DIRECTORY



HANDS-FREE INDOOR UNIT WITH 4.3" COLOR SCREEN. TWO OPTIONS: WITH AND WITHOUT WI-FI CONNECTION FOR CALL ANSWERING WITH A SMARTPHONE.



HANDS-FREE AUDIO INDOOR UNIT

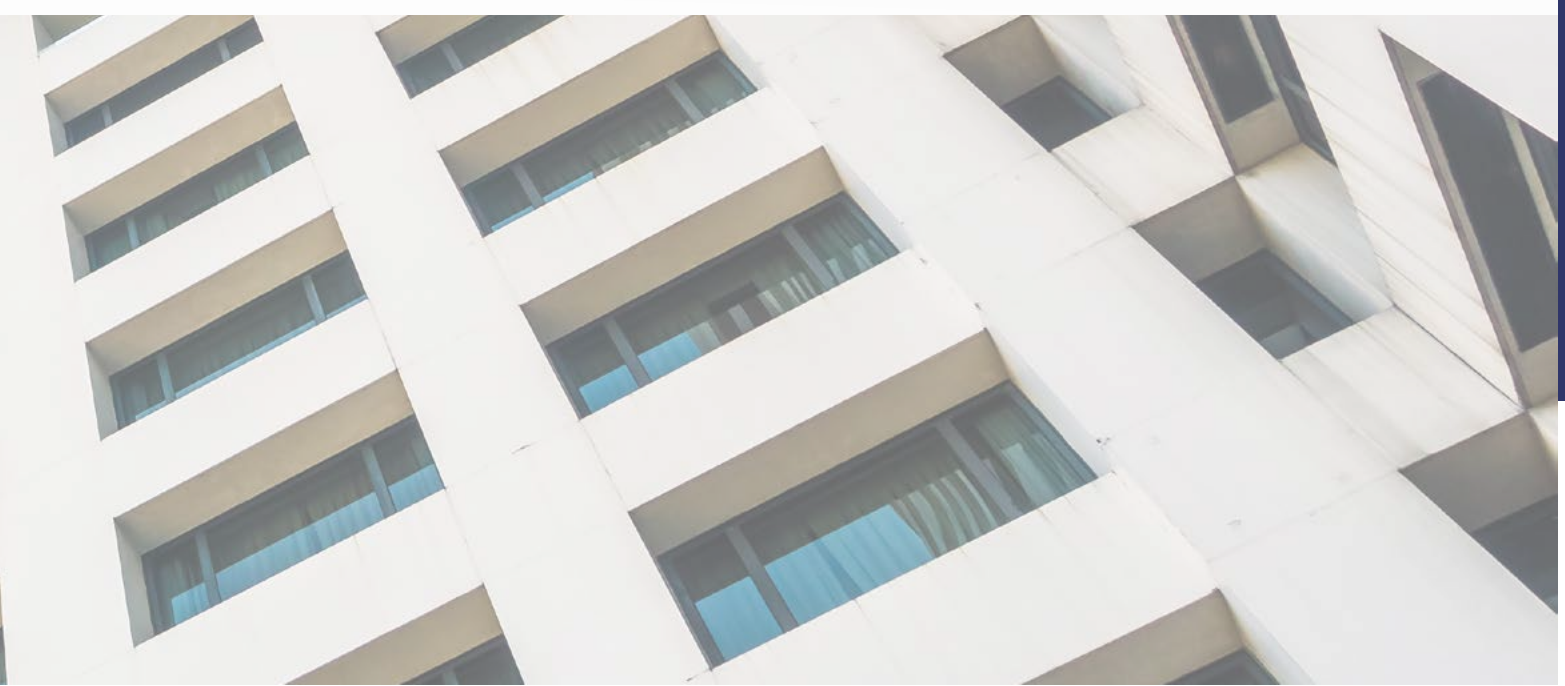

Outdoor panel

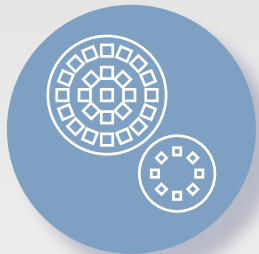

AUTO-ADJUSTING LIGHT SENSOR



HIGH QUALITY CAMERA



LCD DISPLAY WITH SIMPLE AND INTUITIVE



NUMERIC KEYBOARD TO SELECT APARTMENT WITH DIFFERENT PROGRAMMING MODES

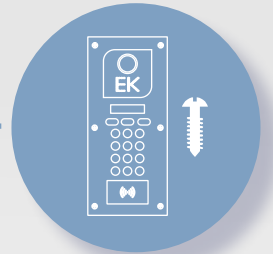

STAINLESS STEEL PANEL WITH ANTI VANDALS SECURITY SCREWS



MIFARE RFID ACCESS CONTROL





**SURFACE OR FLUSH
MOUNTING OPTIONS**

**SURFACE
MOUNTING**

**FLUSH
MOUNTING**





Black outdoor panel option
PCD-E-B



Integration with
PD directory

Outdoor panels 1, 2, 4, 6, 8 buttons. PE 1BM, PE 2B, PE 4B, PE 6B, PE 8B



- ✓ Outdoor panel with camera 1, 2, 4, 6 and 8 buttons
- ✓ Surface installation
- ✓ With protection frame
- ✓ Includes visor Mifare (PE 1BM)

Audio indoor unit UAD



- ✓ Audio call intercom
- ✓ Hands-free
- ✓ Capacitive touch keyboard
- ✓ Wall mounting support included

MON 43V Monitor



- ✓ High quality 4,3" color display
- ✓ Hands-free
- ✓ Outdoor monitoring using the outdoor panel camera
- ✓ Outdoor monitoring using the outdoor panel camera

MON 43W Monitor



- ✓ WiFi High quality 4,3" color display
- ✓ Hands-free
- ✓ Outdoor monitoring using the outdoor panel camera
- ✓ Outdoor monitoring using the outdoor panel camera

Call answering
from
smartphone

PFA 2420 Power supply



- ✓ 2 wires BUS system power supply
- ✓ Central system power supply. PCD-E outdoor panel and DPL-4/DPL-4F splitters intercom module

DPL-4/DPL-4F splitters



- ✓ 4 outputs floor splitters
- ✓ cascable and terminal models
- ✓ Splitting isolation and electrical protection for all apartment systems in the building
- ✓ Use DPL-4F terminal splitter as last splitter to close the line

Extension and regeneration unit EXT 32



- √ Extension and regeneration unit
- √ Required for installations with more than 32 addresses/monitors

Power supply PFA 2425



- √ DIN rail supply 24Vdc/2.5A for EXT 32

Accessories

CE PCD	Flush box for PCD E
VE-AI	Stainless steel protective frame for PCD E outdoor panel
VPS	Protective plastic box for surface mounted PCD E outdoor panel
RF KEY	Mifare type RFID key
CVP 2	2-wire cable 0.5mm ² . 250m reel. Floor wiring
CVP 2-1,5	2-wire cable 1.5mm ² . 200m reel. Long distances wiring



CE PCD

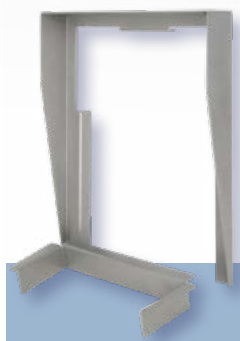

VE-AI



VPS



RF KEY



**CVP2
CVP 2-1,5**

KIT HOME



- ✓ Single-Family Video Door Kit
- ✓ Installation with 2 non-polarized wires
- ✓ Outdoor panel with camera, push button, and Mifare access control
- ✓ Hands-free 4.3-inch color monitor with wall-mount support
- ✓ DIN rail installation power supply
- ✓ Expandable up to 4 monitors and 2 outdoor panels

KIT HOME WIFI



- ✓ Single-Family Video Door Kit
- ✓ Installation with 2 non-polarized wires
- ✓ Outdoor panel with camera, push button, and Mifare access control
- ✓ Hands-free 4.3-inch color monitor with wall-mount support
- ✓ Wi-Fi Connection for Call Forwarding and Remote Door Opening via Smartphone using the EK SMART App
- ✓ DIN rail installation power supply
- ✓ Expandable up to 4 monitors and 2 outdoor panels



Download



Dimensions

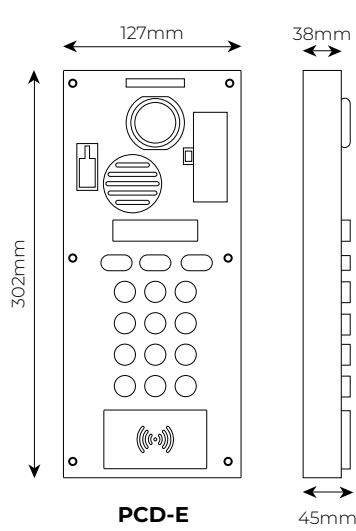

PCD-E

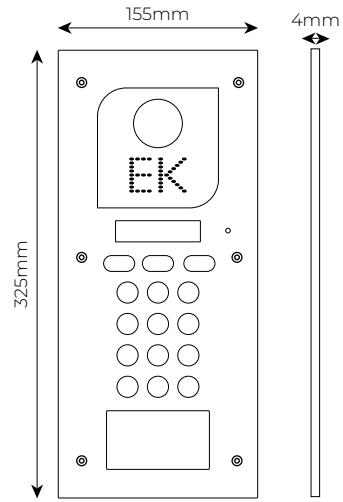

Placa Inox PCD-E

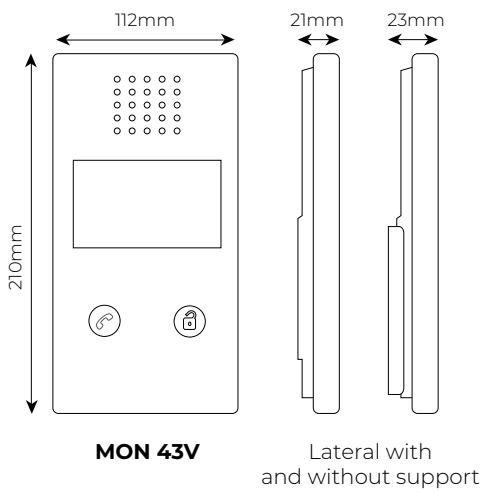

MON 43V

Lateral with and without support

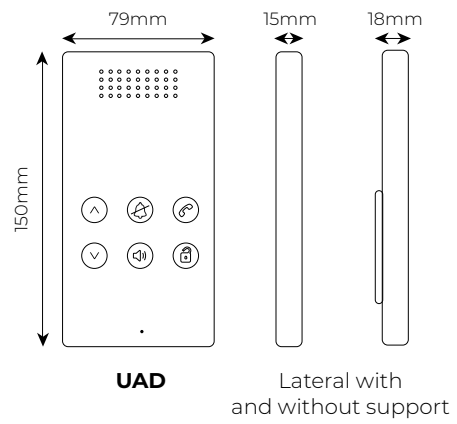

UAD

Lateral with and without support

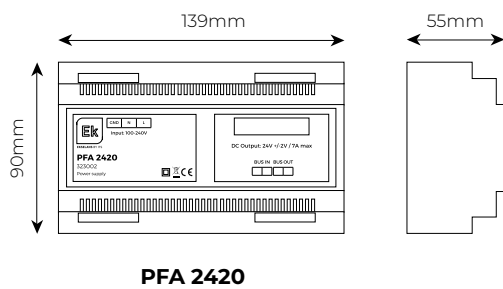

PFA 2420

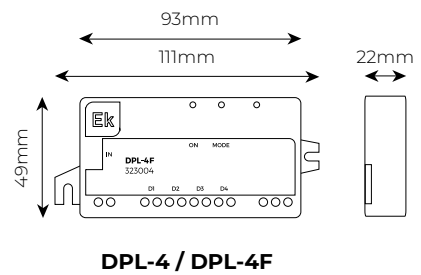

DPL-4 / DPL-4F

Examples of installation schemes

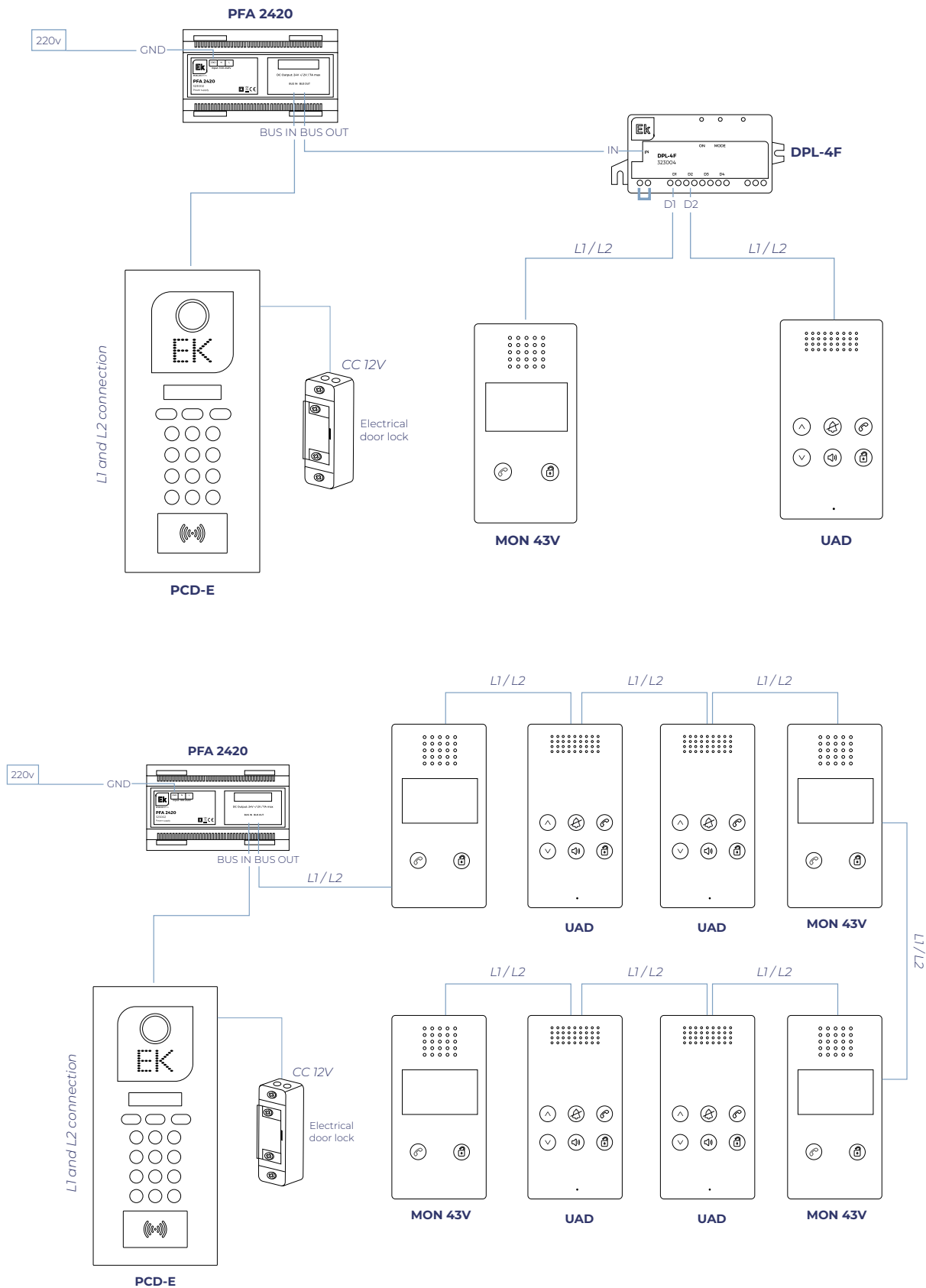

MALETÍN WIFI DEMO · MALETÍN DEMO



- √ Video door building demo kit briefcase
- √ Plug & play
- √ Includes 2 pre-configured keys:
 - 1x Master key
 - 1x Access key





EKSELANS BY ITS

EKSELANS by ITS

ITS Partner O.B.S. S.L

Av. Cerdanyola 79-81 Local C

08172 Sant Cugat del Vallès

Barcelona (Espanya)

Tel: +34 93 583 95 43

info@ek.plus

www.ek.plus